

---

## Class 72 Elevator Starter Set-up Guide

Congratulations, you have just purchased the most advanced, full-featured Elevator Starter available. While this product contains several features to aid in set up, it is important to read and understand this manual before attempting to install. As the set up and wiring of this version is quite different from previous versions of Siemens Elevator Starters, it is equally important to read even if you have a good working knowledge of the 72E version. If questions arise, additional help is available by calling your local Siemens Sales Office. A list of these offices can be found on our website at [www.sea.siemens.com/controls](http://www.sea.siemens.com/controls).

### Special Features:

#### 16 Character by 2 Line Backlit Liquid Crystal Display:

- Displays true RMS Currents for motor and line amps
- Displays true RMS Voltages for the incoming line power.
- Displays Fault Messages and Parameter settings.

#### Easy to use Keypad:

- Set starter parameters
- Scroll through Information and Fault Menus

#### Selectable Stall Prevention:

- User selectable: **Dynamic**, based upon average start time; **Instantaneous**, senses stall condition and reacts immediately; or **Time Based**.

#### Adjustable Current Limit:

- Allows precise control during starting.

### Table of Contents

<b>Special Features:</b> .....	<b>3</b>
<b>Starter Selection</b> .....	<b>4</b>
<b>Features Overview:</b> .....	<b>6</b>
<b>Control Power Connections:</b> .....	<b>7</b>
<b>Motor Connections:</b> .....	<b>10</b>
<b>Inside Delta Motor Wiring</b> .....	<b>10</b>
<b>In Line Motor Wiring:</b> .....	<b>12</b>
<b>LCD Menu</b> .....	<b>13</b>
<b>Basic Configuration of Your Siemens Elevator Starter using The Parameter Menu</b> .....	<b>15</b>
<b>Starter Reset</b> .....	<b>15</b>
<b>Electrical Specifications</b> .....	<b>16</b>
<b>Maintenance and Troubleshooting</b> .....	<b>18</b>

### IMPORTANT

These instructions do not purport to cover all details or variations in equipment, or to provide for every possible contingency to be met in connection with installation, operation, or maintenance. Should further information be desired or should particular problems arise which are not covered sufficiently for the purchaser's purposes, the matter should be referred to the local Siemens office. The contents of this manual shall not become part of or modify any prior or existing agreement, commitment, or relationship. The warranty contained in the contract between the parties is the sole warranty of Siemens Energy & Automation, Inc. Any statements contained herein do not create new warranties or modify the existing warranty.

## Starter Selection

**Table 1: In Delta, 200 – 460 Volt starter ratings**

	HP @ 200V	HP @ 230V	HP @ 460V	Rated Current (Amps)	Overload Range (Amps)	Current Limit Range (Amps)	Manufacturer Catalog Number
In Delta Configuration	5	7.5	15	22	7 - 27	26 - 94	72EG34AFP
	7.5	10	25	35	12 - 44	41 - 148	72GG34AFP
	10	15	30	42	14 - 53	49 - 179	72HG34AFP
	15	20	40	55	18 - 69	64 - 234	72JG34AFP
	20	25	50	68	22 - 85	79 - 289	72KG34AFP
	25	30	60	80	26 - 100	93 - 340	72LG34AFP
	30	40	75	105	35 - 131	121 - 447	72MG34AFP
	40	50	100	130	43 - 163	151 - 553	72NG34AFP
	50	60	125	156	52 - 196	181 - 663	72PG34AFP
75	100	-	252	83 - 315	292 - 1071	72RG32AFP	

**Table 2: In Delta, 460 - 575 Volt starter ratings**

	HP @ 460V	HP @ 575V	Rated Current (Amps)	Overload Range (Amps)	Current Limit Range (Amps)	Manufacturer Catalog Number
In Delta Configuration	15	20	22	7 - 27	26 - 94	72EG35AFP
	25	30	35	12 - 44	41 - 148	72GG35AFP
	30	40	42	14 - 53	49 - 179	72HG35AFP
	40	50	55	18 - 69	64 - 234	72JG35AFP
	50	60	68	22 - 85	79 - 289	72KG35AFP
	60	75	80	26 - 100	93 - 340	72LG35AFP
	75	100	105	35 - 131	121 - 447	72MG35AFP
	100	125	130	43 - 163	151 - 553	72NG35AFP
	125	150	156	52 - 196	181 - 663	72PG35AFP

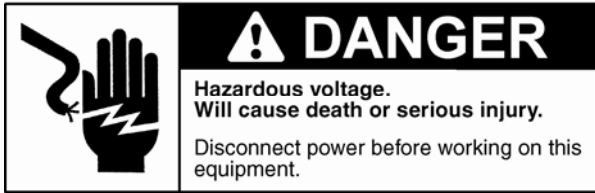
## Starter Selection

**Table 3: In Line, 200 – 460 Volt starter ratings**

	HP @ 200V	HP @ 230V	HP @ 460V	Rated Current (Amps)	Overload Range (Amps)	Current Limit Range (Amps)	Manufacturer Catalog Number
In Line Configuration	-	5	10	18	6 – 25	24 – 85	72GG34AFP
	5	7.5	15	22	8 – 30	28 – 103	72HG34AFP
	7.5	10	20	28	10 – 39	36 – 135	72JG34AFP
	7.5	10	25	35	13 – 49	45 – 166	72KG34AFP
	10	15	30	42	15 – 57	53 – 196	72LG34AFP
	15	20	40	55	20 – 75	70 – 257	72MG34AFP
	20	25	50	68	24 – 93	87 – 319	72NG34AFP
	25	30	60	80	29 – 112	104 – 382	72PG34AFP
	40	50	-	130	48 – 181	168 - 618	72RG32AFP

**Table 4: In Line, 460 - 575 Volt starter ratings**

	HP @ 460V	HP @ 575V	Rated Current (Amps)	Overload Range (Amps)	Current Limit Range (Amps)	Manufacturer Catalog Number
In Line Configuration	10	15	18	6 – 25	24 – 85	72GG35AFP
	15	20	22	8 – 30	28 – 103	72HG35AFP
	20	25	28	10 – 39	36 – 135	72JG35AFP
	25	30	35	13 – 49	45 – 166	72KG35AFP
	30	40	42	15 – 57	53 – 196	72LG35AFP
	40	50	55	20 – 75	70 – 257	72MG35AFP
	50	60	68	24 – 93	87 – 319	72NG35AFP
	60	75	80	29 – 112	104 – 382	72PG35AFP



## Features Overview:

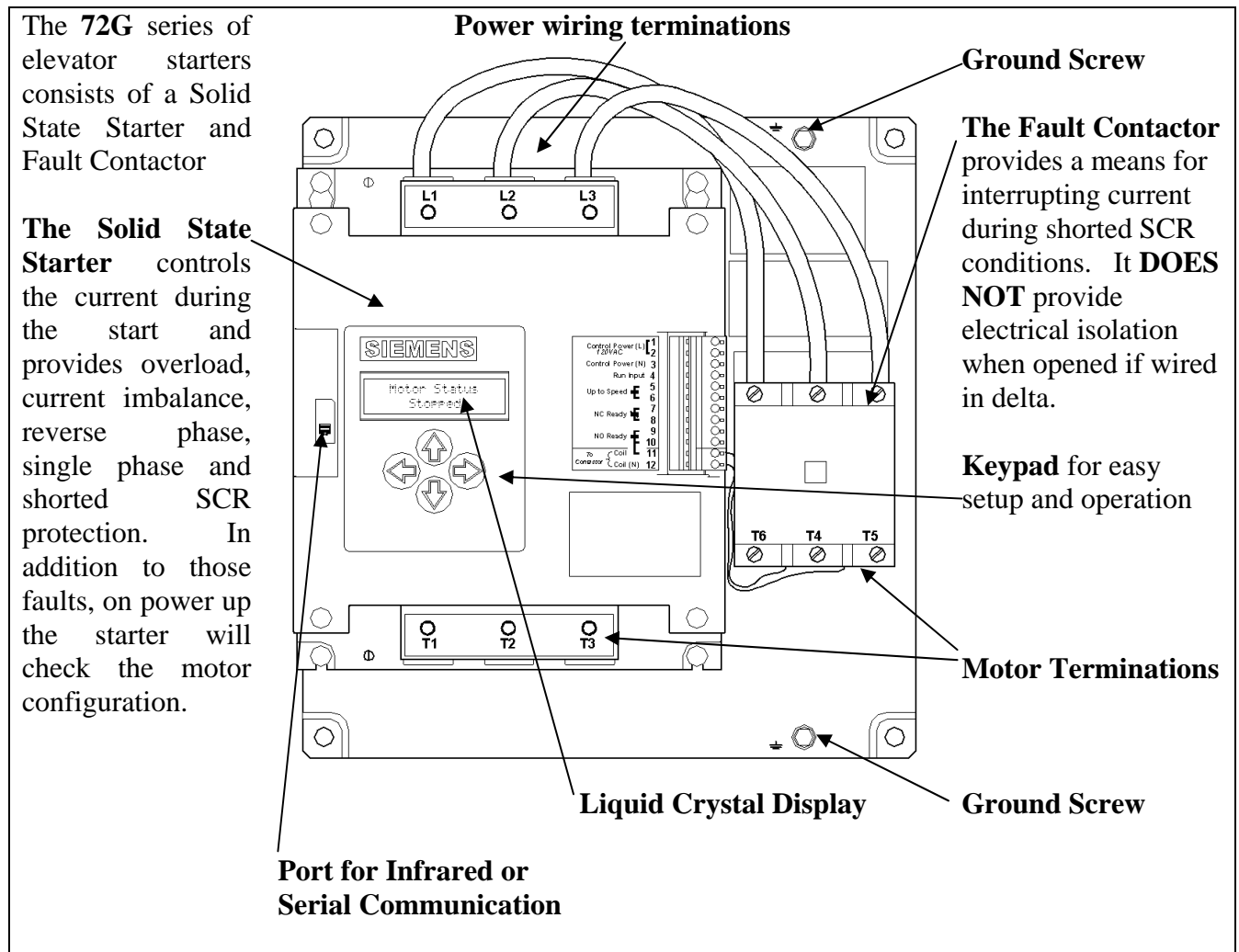
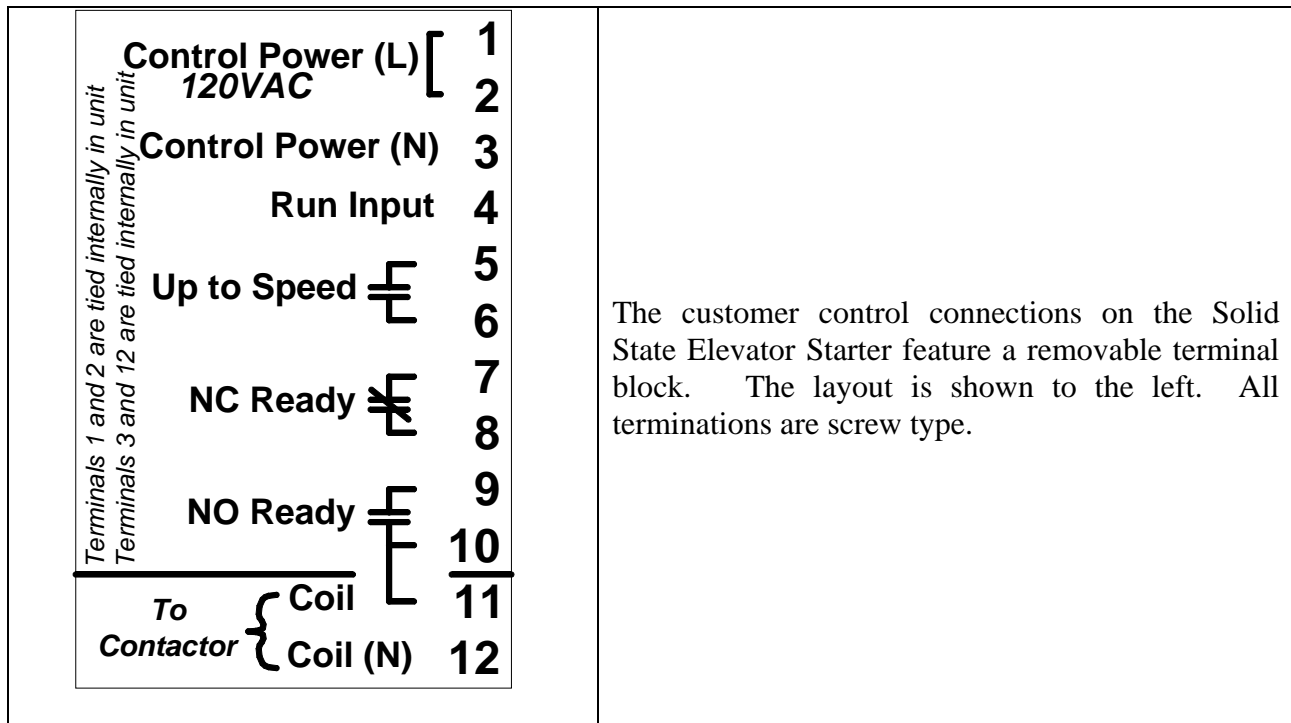


Figure 1: Soft Starter Overview



## Control Power Connections:




<b>CAUTION</b>
<b>Wrong voltage or power rating, may cause property damage.</b>
To avoid possible starter and/or motor damage, be sure the line and control voltage sources are as specified on starter label, and motor rating corresponds to the type of wiring used (Inside Delta or In Line).



Terminal	Customer Connections						
<table border="1"> <tr> <td style="vertical-align: middle; text-align: center;"> <i>ly in unit</i>  <i>ally in unit</i> </td> <td style="text-align: center;"><b>Control Power (L)</b> [ 1</td> </tr> <tr> <td></td> <td style="text-align: center;"><b>120VAC</b> [ 2</td> </tr> <tr> <td></td> <td style="text-align: center;"><b>Control Power (N)</b> 3</td> </tr> </table>	<i>ly in unit</i> <i>ally in unit</i>	<b>Control Power (L)</b> [ 1		<b>120VAC</b> [ 2		<b>Control Power (N)</b> 3	<p>A 120 VAC, 500VA supply should be connected between the Line and Neutral terminals, points 1 and 3. This supply also powers the fault contactor. Terminals 1 and 2 are internally connected. An external jumper wire is required to connect 1 to terminal 9 to feed the NO Ready contacts.</p>
<i>ly in unit</i> <i>ally in unit</i>	<b>Control Power (L)</b> [ 1						
	<b>120VAC</b> [ 2						
	<b>Control Power (N)</b> 3						

**Figure 2:** Control Power Connections


	 <b>DANGER</b>
<p>Hazardous voltage. Will cause death or serious injury.</p>	
<p>Disconnect power before working on this equipment.</p>	

Terminal	Customer Connections
<p>Terminals 1 and 2 are normally in series and terminals 3 and 12 are normally in parallel.</p> <p><b>Control Power (N) 3</b> <b>Run Input 4</b></p>	<p>The 120 VAC motor run signal is connected to terminal 4. The neutral of the motor run circuit must be referenced to terminal 3, the neutral of the Control Power input.</p>
<p>Terminals 5 and 6 are tied internally.</p> <p><b>Up to Speed</b>  <b>5</b> <b>6</b></p>	<p>This output is used to either directly supply power to the Up valves or supply a signal to a control board to indicate the motor is up to speed. This output utilizes a triac rated for 120 VAC.</p>
<p>Terminals 7 and 8 are normally in series.</p> <p><b>NC Ready</b>  <b>7</b> <b>8</b></p>	<p>This contact may be used to signal a control board that the unit is in a fault condition.</p>
<p>Terminals 9, 10, 11, and 12 are normally in series.</p> <p><b>NO Ready</b>  <b>9</b> <b>10</b> <b>11</b> <b>12</b></p> <p>To Contactor { Coil Coil (N)</p>	<p>Terminal 9 should be connected via a jumper wire to either terminal 1 or 2. This provides a hot feed to the fault contactor coil when the <b>NO Ready</b> contact is closed.</p> <p>The terminals marked 10 and 11 are the switched side of the <b>NO Ready</b> contact. This configuration allows terminal 10 to be used to signal that the starter is ready to run while terminals 11 and 12 (neutral for the fault contactor coil) control the fault contactor.</p>

**Figure 2a:** Control Power Connections

**Note:** The load on terminals 5 and 6 must not be greater than 1 amp at 120V. The load on terminals 7 - 11 must not be greater than 3 amps at 120V. All terminals are rated for AC voltages only.

<h2>CAUTION</h2>
<b>Wrong voltage or power rating, may cause property damage.</b>
To avoid possible starter and/or motor damage, be sure the line and control voltage sources are as specified on starter label, and motor rating corresponds to the type of wiring used (Inside Delta or In Line).

	<h2>⚠ DANGER</h2>
	<b>Hazardous voltage. Will cause death or serious injury.</b>
	Disconnect power before working on this equipment.

Typical Control Power Connections:

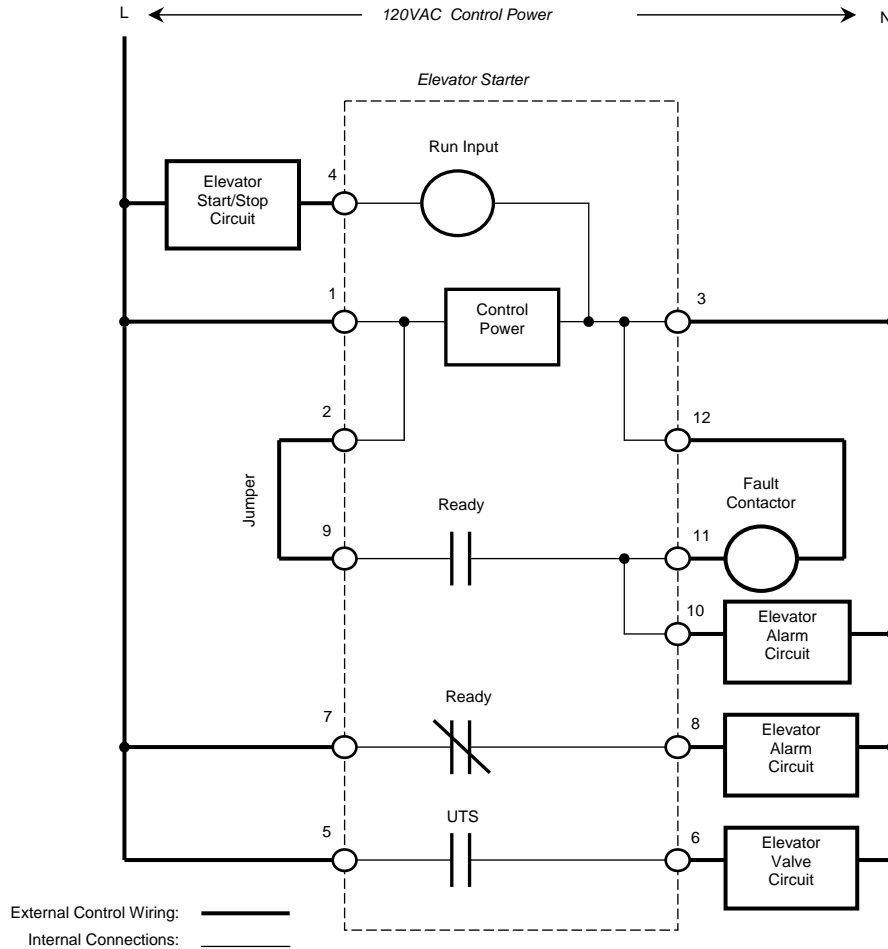
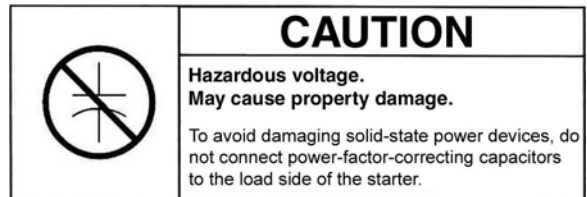
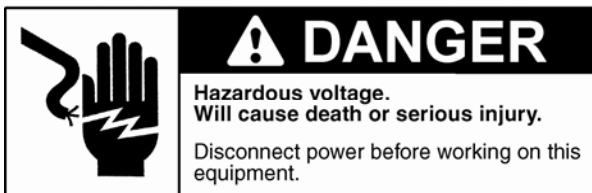


Figure 3

The figure above shows a typical control wiring diagram. While this diagram may not apply to all installations it does show various connections to the starter.



## Motor Connections:

### Inside Delta Motor Wiring

The motor wiring should be connected exactly as shown in Figure 4. If it is not, the starter will detect a motor wiring error. If you have elected to cycle the fault contactor on each start, you must contact technical support for directions on configuring the starter and wiring in a required off delay timer.

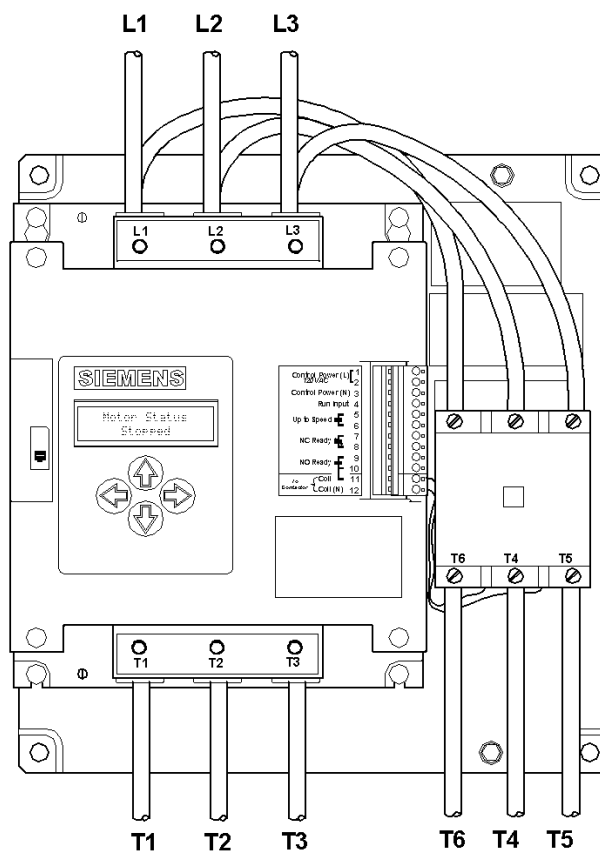
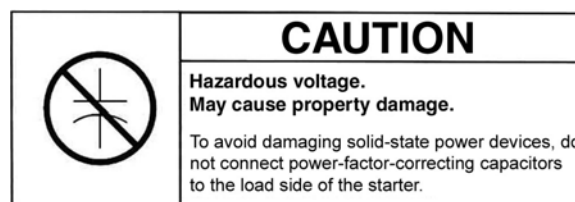
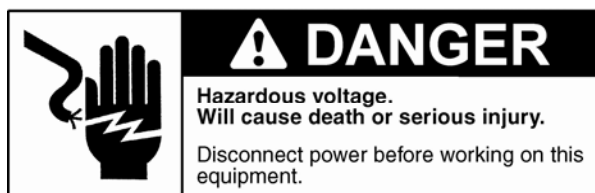
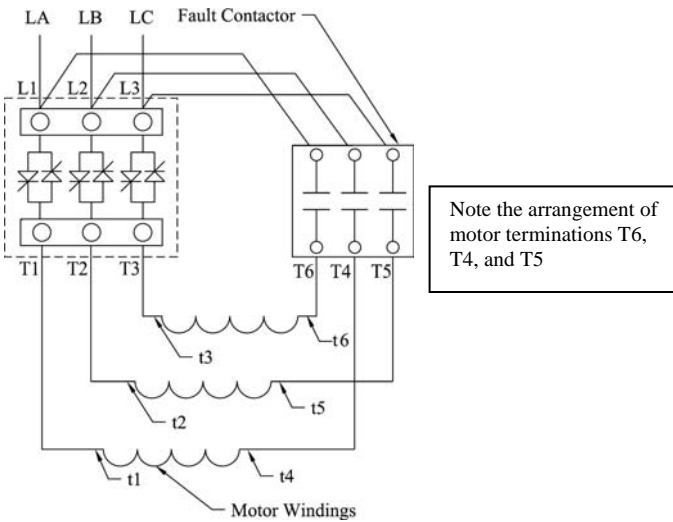


Figure 4: Power Wiring for In-Delta Configuration





## Wiring Diagram

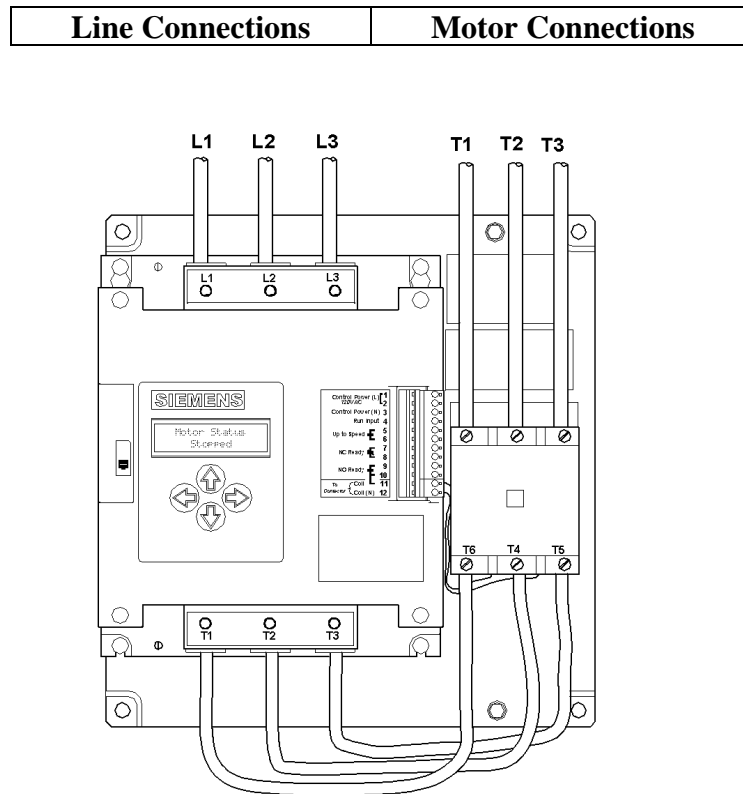


	<h3>Single Voltage Motors</h3> <p>6 lead motor (208 – 575VAC)</p> <table border="1"> <thead> <tr> <th>T1</th> <th>T2</th> <th>T3</th> <th>T4</th> <th>T5</th> <th>T6</th> </tr> </thead> <tbody> <tr> <td>1</td> <td>2</td> <td>3</td> <td>4</td> <td>5</td> <td>6</td> </tr> </tbody> </table>	T1	T2	T3	T4	T5	T6	1	2	3	4	5	6					
	T1	T2	T3	T4	T5	T6												
1	2	3	4	5	6													
<h3>Dual Voltage Motors</h3> <p>High Voltage Connections, 12 lead motor, (460-480 VAC)</p> <table border="1"> <thead> <tr> <th>T1</th> <th>T2</th> <th>T3</th> <th>T4</th> <th>T5</th> <th>T6</th> </tr> </thead> <tbody> <tr> <td>1</td> <td>2</td> <td>3</td> <td>10</td> <td>11</td> <td>12</td> </tr> <tr> <td colspan="2"><b>Connect</b></td> <td>4&amp;7</td> <td>5&amp;8</td> <td>6&amp;9</td> <td></td> </tr> </tbody> </table>	T1	T2	T3	T4	T5	T6	1	2	3	10	11	12	<b>Connect</b>		4&7	5&8	6&9	
T1	T2	T3	T4	T5	T6													
1	2	3	10	11	12													
<b>Connect</b>		4&7	5&8	6&9														
<h3>Low Voltage Connections, 12 lead motor, (220-240 VAC)</h3> <table border="1"> <thead> <tr> <th>T1</th> <th>T2</th> <th>T3</th> <th>T4</th> <th>T5</th> <th>T6</th> </tr> </thead> <tbody> <tr> <td>1,7</td> <td>2,8</td> <td>3,9</td> <td>10,4</td> <td>11,5</td> <td>12,6</td> </tr> <tr> <td colspan="2"><b>Connect</b></td> <td>1&amp;7</td> <td>2&amp;8</td> <td>12&amp;6</td> <td></td> </tr> </tbody> </table>	T1	T2	T3	T4	T5	T6	1,7	2,8	3,9	10,4	11,5	12,6	<b>Connect</b>		1&7	2&8	12&6	
T1	T2	T3	T4	T5	T6													
1,7	2,8	3,9	10,4	11,5	12,6													
<b>Connect</b>		1&7	2&8	12&6														

**Figure 4a: Motor Wiring for In Delta Applications**

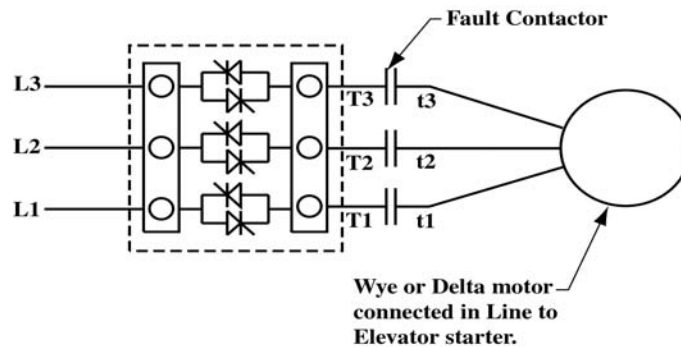
**Note:** This Solid State starter is wired at the factory for in-delta operation on 6 and 12 lead motors only! If you have a 9 lead delta motor, you must run it as the “In Line” configuration show on the following page. If you have a submersible application where only 3 motor leads are brought to the starter, you may elect to run the starter “in line” also. When running “in line”, the correct size starter must be used. The following pages show how to connect the starter in the “In Line” configuration.

## In Line Motor Wiring:

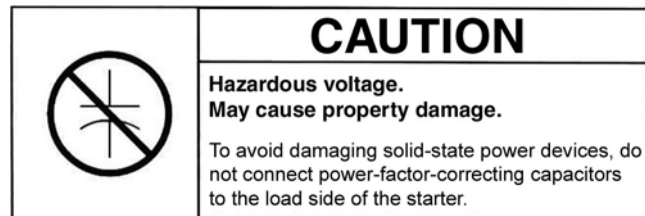
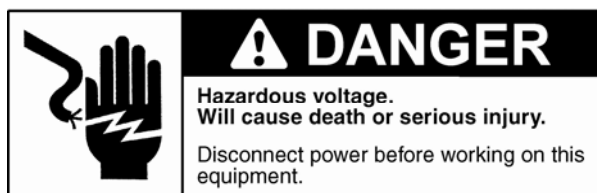


**Figure 5:** Conversion for In Line Applications

It is up to the end user to reconfigure the leads from the starter to the fault contactor for In-Line operation



**Figure 5a:** Motor wiring for in line Applications



## LCD Menu

Upon power up the LCD will display the status of the starter. If a fault is present, it will be displayed.

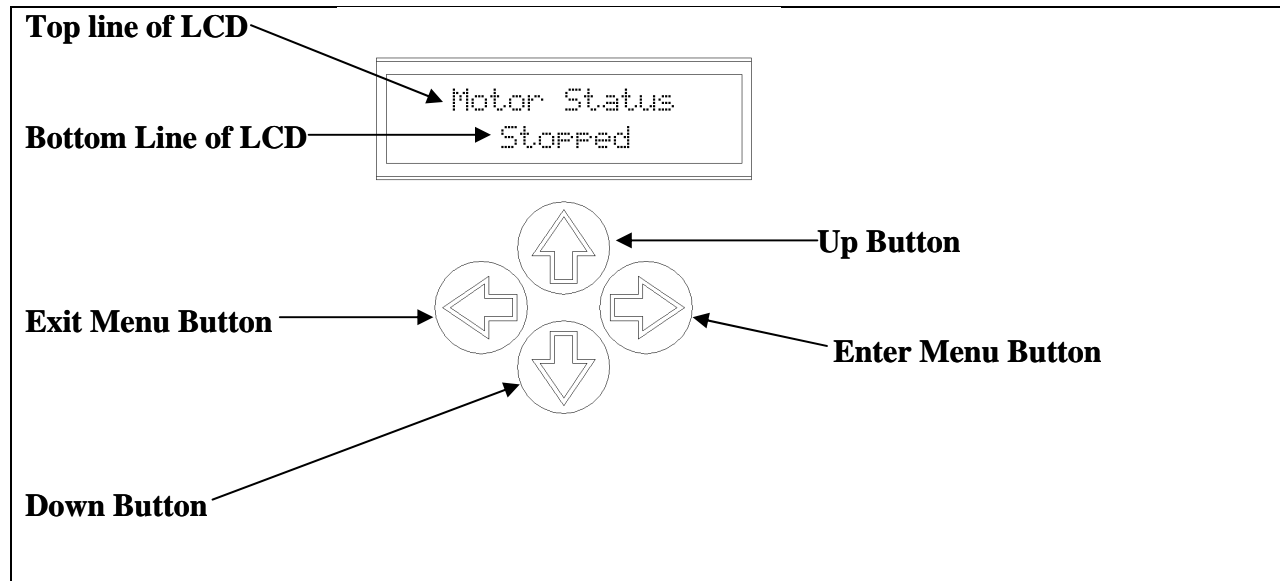
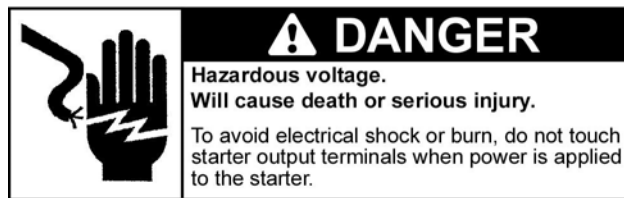


Figure 6



Up Button	This key is used to move up in all of the menu structures. It also is used to increase or select different parameters in the parameter adjust mode.
Exit Button	This key is used to exit menus and to exit the parameter adjustment menus after selections have been made.
Enter Button	This key is used to enter menus and to enter the parameter adjustment menus.
Down Button	This key is used to move down in all of the menu structures. It also is used to decrease or select different parameters in the parameter adjust mode.

# Menu Tree:

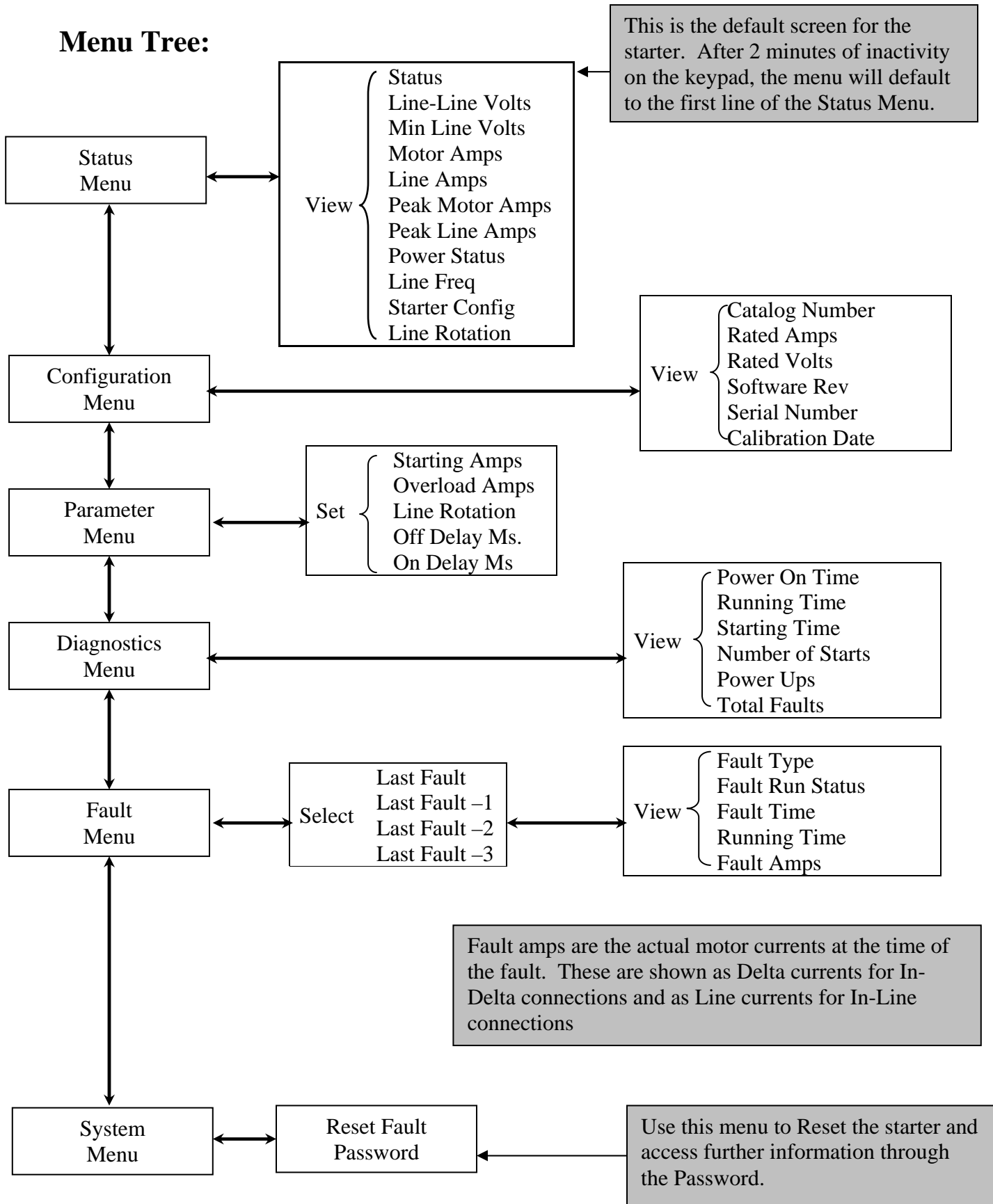
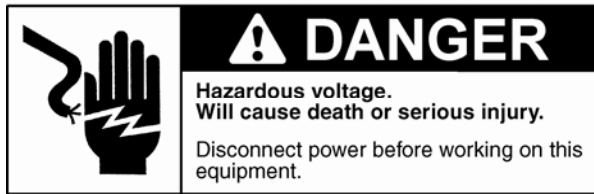


Figure 7



## Basic Configuration of Your Siemens Elevator Starter using The Parameter Menu

Enter the desired settings in the Parameter Menu as indicated below. The factory default settings are shown in the default setting. Use the Up or Down keys to reach the desired parameter. Use the right arrow key to enter the edit mode. Use the right arrow key to select the digit to edit. Use the Up and Down keys to decrease or increase the flashing digit. When the desired value has been entered, use the Left key to exit. After exiting the editing menu, a screen asking you to accept or reject the changes will appear. The bottom line shows the new parameter. The sample screen shown below would be displayed if the Starting Amps parameter was changed to 350 Amps. Use the Up key to accept the change or the Down key to reject the change.

↑Accept ↓Reject  
 350 Amps

Menu Choice		Default Setting
Starting Amps	This is the level that the elevator starter will hold the current limit to during the start. Keep in mind that while lower settings reduce the inrush currents, they increase the starting time. This setting should not be less than twice the motor's FLA.	425% of the starter current rating as measured in Amps
Overload Amps	This setting should be set at or below the FLA of the hydraulic pump motor.	50% of the starter rating in Amps
Line Rotation	The choices for this are either ABC or CBA. To change the setting from the factory default of ABC rotation, select the right key, which causes the ABC to flash and select the up key. To exit select the left key.	ABC Rotation
Off Delay	This is the time the starter continues to run after the run signal has been removed. This value is adjustable from 0 to 2500 milliseconds. To change from the factory default of 500 milliseconds, press the right key then select the desired setting the same using the up, down and right keys. Once the desired value is reached, press the left key to exit.	500 milliseconds
On Delay	This is the time the starter waits before running after receiving a run signal. The factory default is 0 milliseconds. This value is adjustable from 0 to 2500 milliseconds. It is adjusted the same way the Off delay is adjusted.	0 milliseconds

### Starter Reset

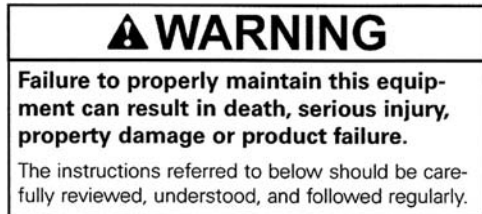
Menu Choice	
Reset Fault	<p>To reset the starter, press the right key followed by the up key and the left key.</p> <p>The starter may also be reset by pressing both the Up and Down keys at the same time or by cycling the control power.</p>

# Electrical Specifications

<b>Input Power and Control</b>	<b>Control Power</b> Operating frequency	$\pm 15\%$ of 120 VAC 50/60 Hz
	<b>Three Phase</b>	-15%/+10% 200-460 VAC -15%/+10% 460-575 VAC $\pm 5$ Hz of 50/60 Hz
	<b>Motor Run Input</b>	Pull in: 79 VAC max. Drop out: 20 VAC min. Off State Leakage: 1.5mA max.
	<b>Up to Speed Output</b> Number of Contacts Rated Operational Current Make/Break VA Expected Operations @ rated load	Solid State, AC Voltages Only 1 Normally Open 1 Amp @ 120 VAC 1200 VA for 250 mS / 120 VA $10 \times 10^6$ cycles
	<b>Ready Output</b> Number of Contacts  Rated Operational Current Make/Break VA Expected Operations @ rated load	Mechanical Relay 1 Normally Open, 7 & 8 1 Normally Closed 9 & 10,11 3.0 Amps @ 120 VAC 3600/360 VA 100,000 cycles
<b>Duty Cycle Rating</b>	Duty Cycle Starts per hour	30% @ 140% of rated FLA 80
<b>Motor Protection</b>	Overload	Class 5, adjustment range is 33% to 125% of Rated Amps
	Current Imbalance	Adjustable trip ratio (lowest motor winding current divided by the highest motor winding current) from .1 to .75. Two second delay allows for system to recover if possible.
	Shorted S.C.R.	Trips in 2 seconds if a shorted SCR is detected.
	Fault Contactor	Opens on all faults. Note: <b>The motor is not electrically isolated with the contactor open when wired in Delta.</b>

<b>Starter Protection</b>	Fusing and/or circuit breaker provided by customer	Fuse: Size per NEC with maximum interrupting capability of 100,000 amps. Breaker: sized per NEC with maximum interrupting capability of 42,000 amps.
<b>Adjustment</b>	Current Limit Overload Incoming Phase Rotation Off Delay On Delay	116% to 425% of starters rating in amps. 33% to 125% of starters rating in amps. ABC or CBA 0 to 2500 mS 0 to 2500 mS
<b>LCD</b>	Type Backlight	16 characters by 2 lines On for two minutes after last keypad input.
<b>Environmental</b>	Operating Temperature Humidity	0 - 50° C 5% ...95% non-condensing
<b>Agency Approvals</b>	UL and cUL  CSA	UL & cUL 508 File Number: E1878467, 02NK50596  File Number: LR6535 Report Number: 2003-1

## Maintenance and Troubleshooting



### General Guidelines:

Failure to properly maintain this equipment can result in death, serious injury, and property damage or product failure. The instructions referred to below should be carefully reviewed, understood, and followed regularly:

**Step 1** - The following NEMA standards should be used as the basis of a preventive maintenance program:  
ICS 1.1-1984 (R1988) "Safety guidelines for the Application, Installation, and Maintenance of Solid State Control."

ICS 1.3-1986 (R1991) "Preventive Maintenance of Industrial Control and Systems Equipment."

**Step 2** - If the torque requirements for wiring connections are not legible, refer to UL 486 "Equipment Wiring Terminals" for nominal torque values.

**Step 3** - In the circumstance of a fault condition as indicated by the opening of a short circuit protective device, refer to annex A ("Maintenance of Motor Controllers After a Fault Condition") of NEMA standard ICS 2-1993 "Industrial Control and Systems, Controllers, Contactors, and Overload Relays Rated Not More Than 2000 Volts AC or 750 Volts DC."

This checklist does not represent an exhaustive survey of maintenance steps necessary to ensure safe operation of the equipment. Particular applications may require further procedures. Should further information be desired the matter should be referred to the local sales office.

Dangerous voltages are present in the equipment which can cause death, serious injury, or property damage. Always de-energize and ground the equipment before maintenance. Maintenance should be performed only by qualified personnel.

The use of unauthorized parts in the repair of the equipment or tampering by unqualified personnel will result in dangerous conditions which can cause death, serious injury, or equipment damage. Follow all safety instructions contained herein.

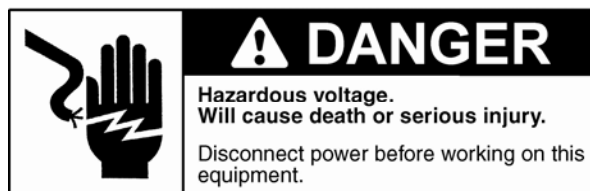
As this is a Solid State device, maintenance is limited to periodically checking the Line and load connections for proper torque and ensuring the heatsink is clean and clear of obstructions.

If the starter utilizes a fan, verify the fan is operating and the opening is clear of obstructions.

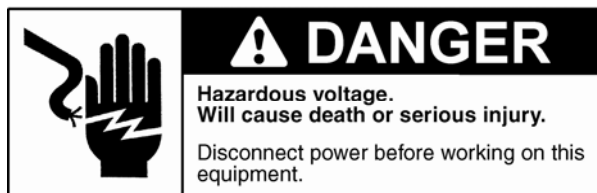


## Troubleshooting Chart:

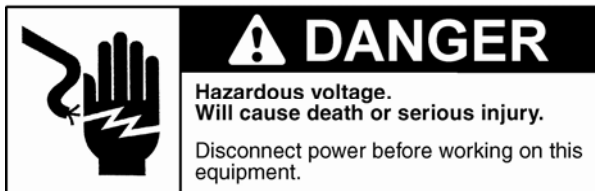
Symptom	LCD Indication	Problem	Solution
LCD not working	No characters displayed on the LCD screen.	Voltage too low or not present at Control Power terminals 1 and 3  Defective Starter	Confirm that control voltage is 120VAC between terminals 1 and 3  If the voltage is greater than 85 VAC replace the starter
Motor will not start	LCD indicates <div style="border: 1px solid black; padding: 5px; text-align: center;">Status Ready</div>	Voltage too low or not present at Run Input terminal 4	Confirm that voltage of 120VAC is present between terminal 3 and Run Input terminal 4  If there is at least 80 VAC present, and the screen still displays “Ready”, replace the starter.
	LCD indicates <div style="border: 1px solid black; padding: 5px; text-align: center;">Control Voltage Powered Down</div>	Voltage too low at Control Power Input.	If the voltage is less than 105 VAC, correct the voltage problem.  If the voltage is greater than 105 VAC replace the starter.
	LCD indicates <div style="border: 1px solid black; padding: 5px; text-align: center;">Control Voltage Brown Out</div>	Voltage too low at Control Power Input.	If the voltage is less than 105 VAC correct the voltage problem.  If the voltage is greater than 105 VAC replace the starter.
	LCD indicates <div style="border: 1px solid black; padding: 5px; text-align: center;">Control Voltage Over Voltage</div>	Voltage too high at Control Power Input.	If the voltage is greater than 140 VAC, correct the voltage problem  If the voltage is less than 140 VAC and the starter is indicating this fault, check for distortion at the peaks of the waveform. Contact Technical support for further information.
	LCD indicates <div style="border: 1px solid black; padding: 5px; text-align: center;">Fault EEPROM Memory</div>	The Starter has detected a problem with the EEPROM Memory	Replace the starter.



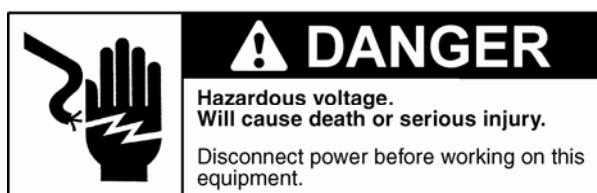
Symptom	LCD Indication	Problem	Solution
Motor will not start (cont.)	LCD indicates <div style="border: 1px solid black; padding: 5px; text-align: center;">Fault ROM Memory</div>	The Starter has detected a problem with the ROM Memory	Replace the starter.
	LCD indicates <div style="border: 1px solid black; padding: 5px; text-align: center;">Fault Watchdog</div>	The Starter has detected an internal fault.	Replace the starter.
	LCD indicates <div style="border: 1px solid black; padding: 5px; text-align: center;">Wrong Rotation CBA set as ABC</div> or <div style="border: 1px solid black; padding: 5px; text-align: center;">Wrong Rotation ABC set as CBA</div>	Incoming three phase is opposite of the Line Rotation Setting	<b>Disconnect Line Power:</b> Change two of the incoming phases and verify that the motor is spinning in the correct direction. If the motor does not turn in the correct direction, change the incoming phases back to their original connections and go to the Parameter menu to change the Line Rotation setting.
	LCD indicates <div style="border: 1px solid black; padding: 5px; text-align: center;">Fault Motor Wiring</div>	The motor is not correctly connected to the starter.	<b>Disconnect Line Power:</b> For In Delta Applications the following measurements should be less than 10 ohms:  t1 to center leg, bottom of Fault Contactor t2 to right leg, bottom of Fault Contactor t3 to left leg, bottom of Fault Contactor  For In Line applications, the following measurements should be less than 10 ohms  t1 to t2 t2 to t3 t3 to t1 Correct wiring if necessary



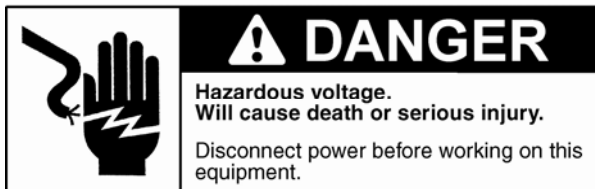
Symptom	LCD Indication	Problem	Solution
Motor will not start (cont.)	LCD indicates <div style="border: 1px solid black; padding: 5px; text-align: center;">           Fault            Motor Wiring         </div>	The Fault Contactor is not being energized	<p>Verify that the fault contactor is being energized after power up. You should hear it pull in then drop out upon power up.</p> <p>If not, measure the voltage from terminal 9 to terminal 12. This should be 110 VAC.</p> <p>Correct any wiring errors if necessary.</p> <p>Connect a voltmeter to terminals 9 and 12. Push the up and down arrows simultaneously and look for the voltage to appear briefly across these terminals.</p> <p>Correct any wiring errors if necessary.</p> <p>If the particular elevator's controls require the fault contactor be cycled with each run, the starter can be configured to check for motor wiring faults only when the motor run command is initiated. Consult technical support for further assistance.</p>
		Motor is wired correctly, starter still indicates Motor Wiring fault.	<p><b>Disconnect line power.</b>            With an ohmmeter, check for a shorted SCR by measuring the resistance of each phase from the line to load terminals. A shorted SCR typically has a resistance of less than 3000 Ohms.</p> <p>If all three S.C.R.s are acceptable, proceed with the next steps.</p> <p>Move the jumper wire from 9 to 10 on the terminal block.            Re-energize equipment.            Verify that the fault contactor is energized and remains in.            Measure the voltages across the poles of the fault contactor.            If all voltages are less than 5 VAC  <b>Disconnect line power</b> the equipment and move the jumper wire back to terminal 9.            If any of the poles have voltages higher than 5 VAC, contact technical support for further assistance.</p>



Symptom	LCD Indication	Problem	Solution
	LCD indicates <div style="border: 1px solid black; padding: 5px; text-align: center;">Fault Shorted SCR A</div> or <div style="border: 1px solid black; padding: 5px; text-align: center;">Fault Shorted SCR B</div> or <div style="border: 1px solid black; padding: 5px; text-align: center;">Fault Shorted SCR C</div>	The Starter has a shorted S.C.R. in the indicated phase	<p><b>Disconnect line power.</b> With an ohmmeter, check for a shorted SCR by measuring the resistance of each phase from the line to load terminals. A shorted SCR typically has a resistance of less than 3000 Ohms.</p> <p>If the S.C.R.s are acceptable, and the wiring configuration is In Line, Consult Technical Support for Further information.</p>
	LCD indicates <div style="border: 1px solid black; padding: 5px; text-align: center;">Fault Highline Volts</div>	The unit has detected a highline condition on the incoming voltage lines.	Check the Line Voltages in the Status Menu. If one or more of the incoming lines are over 528 volts for 460 volts units or 632 volts for 575 volt units, verify the reading with a meter. If the meter reading matches the starter's reading, correct the voltage problem. If the meter reading does not agree with the starters voltage reading, contact technical support.
Motor Starts, but does not come up to speed in a timely manner, or at all.	LCD indicates <div style="border: 1px solid black; padding: 5px; text-align: center;">Status Maintain Start</div> before switching to <div style="border: 1px solid black; padding: 5px; text-align: center;">Status Ramp to 450%</div>	Current limit is set too low or there is an excessive load on the system during the start.	<p>Check the current limit setting in the Parameter menu. This should not be set below 200%. Verify that the overload setting is correct.</p> <p>Verify that the valves are not being energized during the start.</p> <p>Increase current limit if necessary.</p> <p>If using the starter "In Line", verify that the unit is sized correctly for the motor.</p>



Symptom	LCD Indication	Problem	Solution
Motor trips out on a fault after coming up to speed.	LCD indicates <div style="border: 1px solid black; padding: 5px; text-align: center;">           Fault Low Leg Amps         </div>	The starter has detected an imbalance in the motor currents	<p>Check the fault currents in the Fault Menu or with a computer or PDA using the required interface. Compare these to the currents seen during the start and before the faults occur.</p> <p>If possible, verify the currents with a clamp on ammeter.</p> <p>Check the voltages across the SCRs, by measuring across the line and load terminals, when the unit is up to speed. These voltages should be less than a few volts. If any are above 10 VAC, contact technical support.</p> <p>The Default trip point for the ratio of the lowest to the highest current is .33. This setting is adjustable in the OEM menu accessible via a password. If the setting has to be adjusted, contact technical support.</p>
	LCD indicates <div style="border: 1px solid black; padding: 5px; text-align: center;">           Fault Phase Loss         </div>	The starter detected a problem with the incoming three phase power during a run condition.	<p>This fault will reset when the power returns to normal. To view the exact line voltages when the fault occurred, view the diagnostic screen via a laptop computer or PDA.</p>

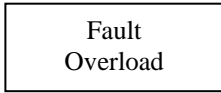


## Symptom

Motor trips out on an Overload fault after coming up to speed.

## LCD Indication

LCD indicates



## Problem

The Overload setting is set too low.

## Solution

Check the fault currents, Run Status and Run Time; accessible in the Fault Menu or with a computer or PDA using the required interface.

For Inside Delta applications, displayed fault currents should be multiplied by 1.73 to get an approximate line value.

Verify the fault occurred during the “Maintain Current Limit”, “Ramp to 450%” or “Maintain 450%”.

Verify the starting current limit is set to at least 200% of the motor FLA.

If the overload fault is occurring during the “maintain 450%” and the run time is several seconds, there may be a mechanical issue preventing the motor from coming up to speed.

Verify that there is some type of viscosity control, either heaters or recirculation. If this is not the case, contact technical support for assistance on configuring the “Instantaneous Stall Protection”.

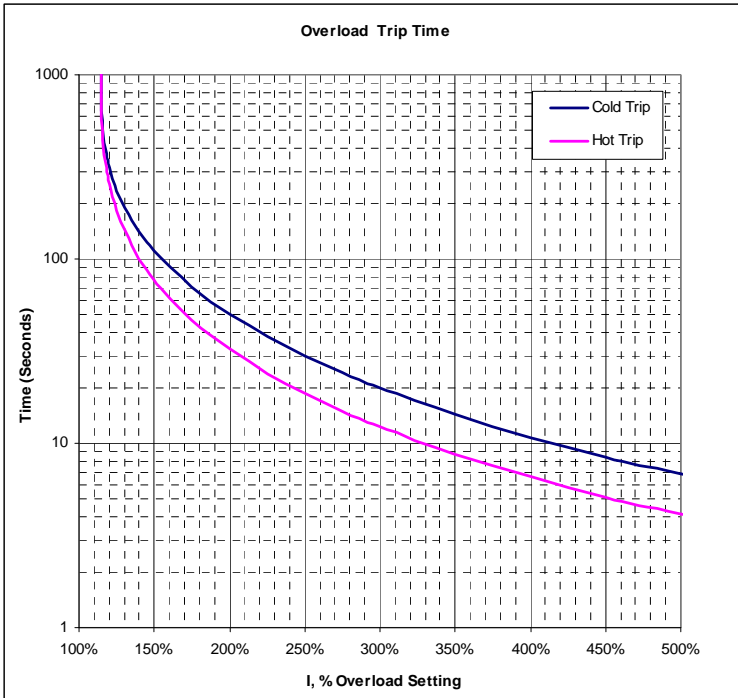


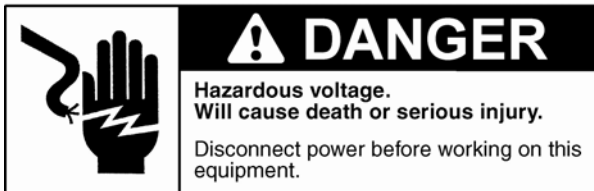
Figure 8

The Starter has detected an Overload condition while up to Voltage

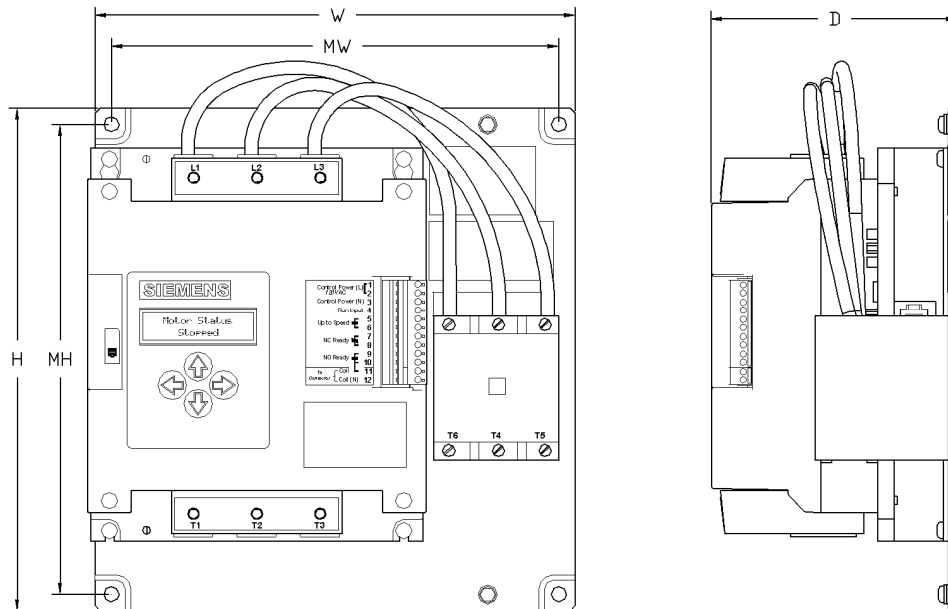
The overload setting should be set to the FLA of the motor. See Figure 8 for the Class 72 starter trip curves.

If the overload is set correctly you need to determine the cause of the higher currents. If the fault currents multiplied by 1.73 are in excess of the Power Unit’s rated amps under a Full load condition, there may be a mechanical problem.

In addition to the above, if the overload mode is set for “All 3 Phases” and one winding’s current is significantly higher than the other windings, nuisance overload trips may occur during long up runs near or at the rated up load.



## Starter Dimensions:



All dimensions are shown in inches

Catalog Number	H	W	D	MH	MW
72EG34AFP – 72KG34AFP	11.50	11.00	5.63	10.75	10.25
72LG34AFP – 72PG34AFP	11.50	11.00	7.13	10.75	10.25
72RG32AFP	12.00	16.75	7.16	11.00	15.75
72EG35AFP – 72KG35AFP	11.50	11.00	5.63	10.75	10.25
72LG35AFP	11.50	11.00	7.13	10.75	10.25
72MG35AFP – 72PG35AFP	12.00	16.75	7.13	11.00	15.75

Note: All panel mounting holes are 5/16". Starter and Fault contactor can extend up to 1/4" beyond the width of the mounting panel.